



Radio Bridge LoRaWAN[®] Wireless Sensor

Tilt Sensor User Guide



LoRaWAN Wireless Tilt Sensor

Model: RBS3010NA09BN00, RBS3010EU09BN00

Part Number: RB00019 Rev. 2.1

Trademarks and Copyright

Copyright

This publication may not be reproduced, in whole or in part, without the specific and express prior written permission signed by an executive officer of Multi-Tech Systems, Inc. All rights reserved. Copyright © 2023 by Multi-Tech Systems, Inc.

Trademarks and Registered Trademarks

MultiTech, the MultiTech logo, DeviceHQ, and Conduit are registered trademarks of Multi-Tech Systems, Inc. All other products and technologies are the trademarks or registered trademarks of their respective holders.

Disclaimers

Information in this document is subject to change without notice and does not represent a commitment on the part of Multi-Tech Systems, Inc.. Multi-Tech Systems, Inc. provides this document “as is,” without warranty of any kind, expressed or implied, including, but not limited to, the implied warranties of fitness or merchantability for a particular purpose. Multi-Tech Systems, Inc. may make improvements and/or changes in this manual or in the product(s) and/or the software described in this manual at any time.

Legal Notices

See the [Legal Notices](#) section of the website for up-to-date information on MultiTech warranty, returns policy, privacy statement, terms of sale, and terms of service.

Customer Support

Sales	Support
sales@multitech.com	support@multitech.com
+1 (763) 785-3500	+1 (763) 717-5863

Website

<https://www.multitech.com>

Knowledge Base

For immediate access to support information and resolutions for MultiTech products, visit <https://www.multitech.com/kb.go>.

Support Portal

To create an account and submit a support case directly to our technical support team, visit: <https://support.multitech.com>.

World Headquarters

Multi-Tech Systems, Inc.
2205 Woodale Drive, Mounds View, MN 55112
USA

Contents

Chapter 1 – Overview	5
Part Numbers	5
Documentation	5
Chapter 2 – Preparing Sensor	6
Preparing an RBS301 Sensor	6
Quick Start.....	6
Mounting the Sensor	7
Mounting the Sensor with the Tamper Screw.....	7
Chapter 3 – Hardware Specifications and Information	8
Absolute Maximum Ratings	8
Battery Life.....	8
Replacing the Battery.....	9
Mechanical Drawings.....	10
Indoor RBSx01 Sensors	10
Chapter 4 – Safety	11
Lithium Battery Safety	11
User Responsibility.....	11
Chapter 5 – Common Messages	12
Common Messages.....	12
Message Protocol.....	12
Uplink Messages	12
Reset Message (0x00)	13
Supervisory Message (0x01)	15
Tamper Message (0x02).....	16
Downlink ACK (0xFF)	17
Link Quality Message (0xFB)	17
Downlink Messages.....	17
General Configuration.....	18
Device Info Request	21
Link Quality Configuration (0xEE)	21
ADR Advanced Configuration.....	22
Factory Reset (0xEC)	22
Advanced Configuration (0xFC)	22
Chapter 6 – Sensor-Specific Messages.....	23
Uplink Messages	23
Downlink Messages.....	23
Thresholds.....	24

Hold Time	24
Report-On-Change	24
Control Byte	24
Chapter 7 – Regulatory Information	25
47 CFR Part 15 Regulation Class B Devices	25
Federal Communications Commission (FCC)	25
Industry Canada Class B Notice.....	26
EMC, Safety, and R&TTE Directive (RED) Compliance	26
Standards	26
Harmonized Commodity Description (HS Code).....	27
Export Control Classification Number (ECCN).....	27
Chapter 8 – Environmental	28
REACH-SVHC Statement	28
Registration of Substances.....	28
Waste Electrical and Electronic Equipment Statement	28
WEEE Directive.....	28
Instructions for Disposal of WEEE by Users in the European Union	28
Restriction of the Use of Hazardous Substances (RoHS)	29

Chapter 1 – Overview

The LoRaWAN tilt sensor uses an accelerometer to detect transitions between horizontal and vertical orientation, as well as reporting the angle of tilt. When the sensor is rotated from horizontal to vertical or vice versa, an alert is sent to the wireless network. The thresholds for triggering a tilt event are configurable over the air.

Part Numbers

Part Number	Rating	Wireless	Region
RBS3010NA09BN00	Indoor	LoRaWAN	North America
RBS3010EU09BN00	Indoor	LoRaWAN	Europe

Documentation

The following documentation is available at <https://www.multitech.com/brands/reveal-wireless-movement-sensors>.

Document	Description	Part Number
User Guide	This document provides overview, safety and regulatory information, design considerations, schematics, and general hardware information.	RB00019
Connection Guide	This document provides instructions and information on how to connect LoRaWAN sensors on gateways and networks.	RB00001

Chapter 2 – Preparing Sensor

Preparing an RBS301 Sensor

Sensors ship with batteries installed. There is a plastic tab over the battery, which needs to be removed.

- Pull the tab out of the sensor to connect the battery. If the tab does not pull out easily, you may need to open the case to remove it.

To open the case:

1. Use a pen or similar object to press the button on the opposite side of the case.

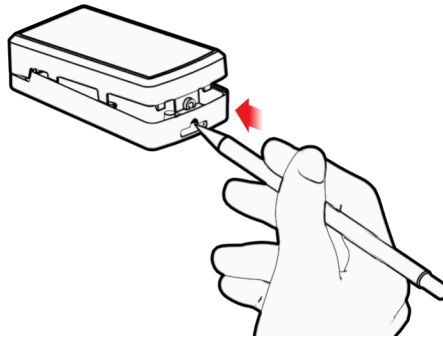

2. Remove the battery tab. You may need to remove the battery to remove the tab.
3. Re-insert the battery and close the case.

Quick Start

Use your sensor through either the console or a third-party network. To use the console, use the following steps. To use a third-party network, refer to the *Connecting LoRaWAN Sensors on Gateways and Networks (RB00001)*, which is available through the sensor page at <https://www.multitech.com/products/sensors>

1. Create a console account at: <https://console.radiobridge.com/>
2. Click on **Devices** on the left.
3. Click **Add Device**.
4. Select the network you want to use.
5. Make sure Console Only Device is NOT selected.
6. Specify if you want to **Register Through Radio Bridge** or use an existing account with the network.
7. Enter the **Device Name**, **Device ID**, and **Device Key**.

Note: For easy Device ID and Key entry, scan the QR code on the yellow key card included with your device. Then copy and paste data into the console. With the QR code, the first line is the Device ID and the rest is the key.

8. Select the model from the **Device Type** drop down. Model is on the device label.
9. Set the **Join EUI** to **7894E80000000000** and click **Continue**.
10. Review the summary and click **Confirmation**.

The console shows complete when the device is successfully added.

Mounting the Sensor

Do not mount higher than 2 meters from floor surface.

To mount the sensor:

- Use the large adhesive pad included with a sensor to secure the case in position.

Mounting the Sensor with the Tamper Screw

For increased security, open the case, and fasten it to the wall using the included tamper screw as shown. Then reassemble the case. The tab will break away and send a tamper alert if the case is forcibly removed.

1. Open the case. To do this, use a pen or similar object to press the button on the opposite side of the case.

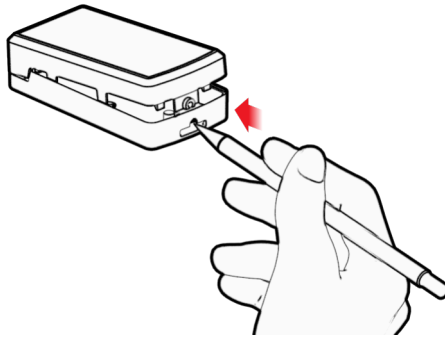

2. Stick the adhesive pad where you want to install the sensor.
3. Attach the case over the adhesive using the included tamper screw as shown.

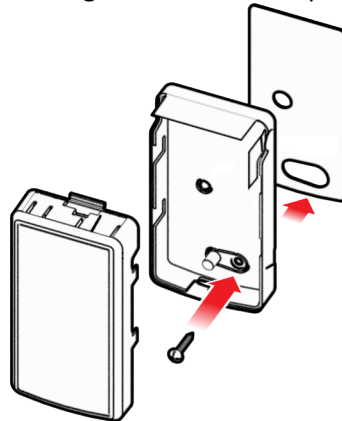

4. Reassemble the case.

The tab will break away if the case is forcibly removed. If you enabled the sensor's tamper option, the sensor sends a tamper alert. (Note: Tamper switches are disabled by default.)

Chapter 3 – Hardware Specifications and Information

Absolute Maximum Ratings

Parameter	Rating
Operating ambient temperature (indoor version)	-30°C to +70°C
Operating ambient temperature (outdoor version)	-40°C to +70°C
Storage ambient temperature	-40°C to +90°C

Battery Life

The sensor uses a lithium non-rechargeable battery, capable of an estimated 200,000+ messages.

Note: Refer to the Sensor Battery Estimator.xlsx spreadsheet on the on the sensor's product page for specific battery life estimates:

<https://radiobridge.com/documents/Sensor%20Battery%20Estimator.xlsx>

Battery life depends on the number of transmissions per day. Power required for a message transmission is greater than the “sleep current” for high power radio technologies (e.g, LoRaWAN).

Different battery chemical types deplete over time with different voltage profiles; a lithium battery maintains high voltage for the life of the battery with a rapid drop near the end of life, and an alkaline battery has gradual reduction in voltage over time. Sensors ship with a lithium battery, which is the recommended replacement type.

Recommended battery: Panasonic CR2

Recommended battery: Panasonic CR123A

Battery life estimates in the online spreadsheet assume room temperature, meaning temperatures near the maximum and minimum ratings negatively impact battery life. Battery voltage lowers in cold temperatures, and internal circuitry needs a minimum voltage to operate properly.

Note: Battery life will be reduced in cold environments leading to possible device shut down.

The battery voltage and a low battery indicator are reported by supervisory messages. Refer to the section on Message Protocol for details.

Replacing the Battery

Replacement battery type is listed in the Battery Life topic. To replace the battery:

1. Use a pen or similar object to press the button on the opposite side of the case.

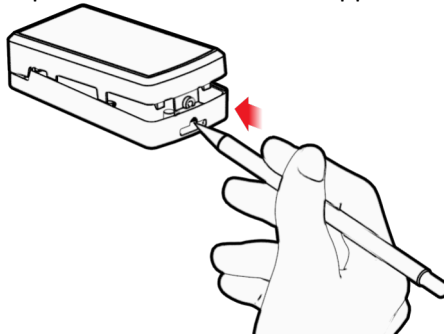

2. Remove the battery.

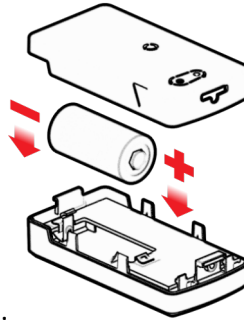

3. Insert the new battery as shown.
4. Close the case.

Mechanical Drawings

The mechanical drawings provided in this section are for the main body of the sensor. All dimensions use inches unless specified.

Indoor RBSx01 Sensors

ISOMETRIC
TOP VIEW

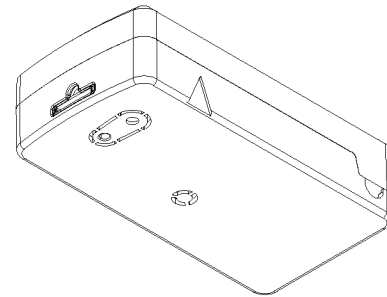
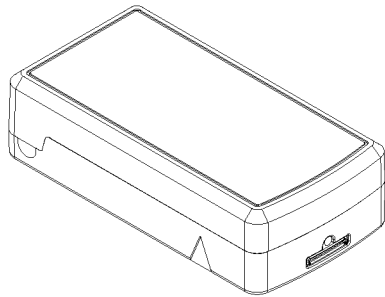

ISOMETRIC
BOTTOM VIEW

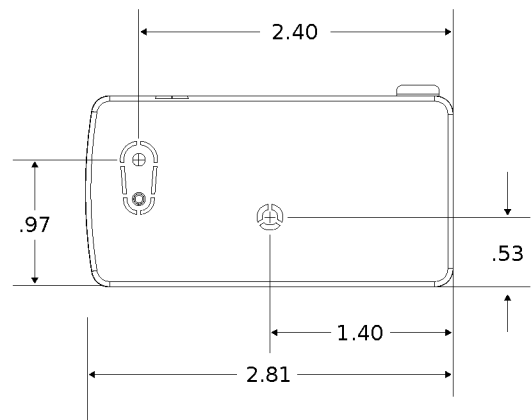
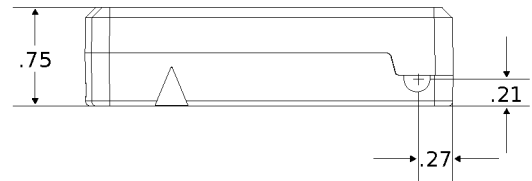
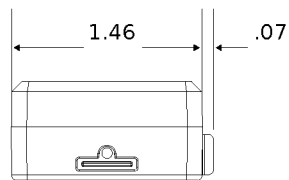

Chapter 4 – Safety

Lithium Battery Safety

CAUTION: The battery used in this device may present a fire or chemical burn hazard if mistreated. Do not recharge, disassemble, heat above 100°C (212°F) or dispose of in fire. Replace battery with Panasonic CR123A. Use of another battery may present a risk of fire or explosion. Dispose of batteries according instructions.

Attention: La batterie utilisée dans cet appareil peut présenter un risque d'incendie ou de brûlure chimique si elle est maltraitée. Remplacez la batterie par une Panasonic CR123A. Ne pas démonter, incinérer ou exposer à des températures supérieures à 100°C. Jeter les piles utilisé conformément aux instructions.

Lithium cells and batteries are subject to the Provisions for International Transportation. Multi-Tech Systems, Inc. confirms that the Lithium batteries used in the MultiTech product(s) referenced in this manual comply with Special Provision 188 of the UN Model Regulations, Special Provision A45 of the ICAO-TI/IATA[1]DGR (Air), Special Provision 310 of the IMDG Code, and Special Provision 188 of the ADR and RID (Road and Rail Europe).

User Responsibility

Keep the wireless sensor away from children.

Respect all local regulations for operating your wireless device. Use the security features to block unauthorized use and theft.

End user must operate product per country laws and rules

Chapter 5 – Common Messages

Common Messages

This chapter defines the protocol and message definitions common to all MultiTech wireless sensors. Common messages include basic error messages, tamper, supervisory, link quality, and downlink acknowledgments. Sensor specific messages are in the *Sensor Specific Messages* chapter.

Message Protocol

This section defines the protocol and message definitions for the device.

Note: MultiTech provides a web-based console at console.radiobridge.com for configuring and monitoring devices. We recommend using this console rather than the protocols defined in this section.

If not using the console, use this topic to configure the device through downlink messages and decode the device data.

Uplink Messages

The uplink messages (sensor to web application) have the following structure.

Item	Size	Description
Protocol Version	4 bits	A constant 1, provides extensibility to the specific format of a message type.
Packet Count	4 bits	A sequential number starting at 0 for the first message sent from the sensor to the cloud. It increments by one for each subsequent message. When it reaches 0xF (15 decimal), it wraps back to 0. Packet count helps identify when a message is lost. For example, if the packet count goes 2,4 instead of 2,3,4, it indicates a message has been lost. It can also help identify out-of-order or duplicate messages.
Message Type	1 byte	Byte format is 8 bits. Refer to next table.
Message Payload	0-7 bytes	Each message type has between 0 and 8 bytes of payload data specific to the sensor. Refer to the following table for payload information.
0x00	5-byte reset code	Device has reset. The reset cause is represented in the 5-byte reset code payload.
0x01	>9 bytes	Daily supervisory message (1-2 per day). The 9-byte payload contains current sensor status. Refer to Supervisory Message (0x01) for payload details.

Message Type	Payload	Description
0x02	1-byte event	A tamper event has occurred. Refer to Tamper Message (0x02) for details.
--	Sensor event	Sensor events are defined in the <i>Sensor Specific Messages</i> chapter.

Message Type	Payload	Description
0xfb	Link quality	Sent after each downlink configuration (refer to Link Quality Message) or to periodically ping the network server (refer to Link Quality Check Period).
0xfe	--	Reserved.
0xff	1-byte status	Downlink message ACK. Refer to Downlink ACK for more detail.

Reset Message (0x00)

Every time a sensor powers up it sends a reset message to the cloud.

The reset message payload is defined in the following table.

Bytes	Description
0	Sensor type code, a product identifier sent as part of the reset message. (The following code is specific to your device).
	Door/Window 0x01
	Door/Window High Security 0x02
	Contact 0x03
	Temperature No-Probe 0x04
	Temperature External Probe 0x05
	Temperature Internal 0x19
	Single Push Button 0x06
	Dual Push Button 0x07
	Acceleration-Based Movement 0x08
	Tilt 0x09
	Water 0x0a
	Tank Level Float 0x0b
	Glass Break 0x0c
	Ambient Light 0x0d
	Air Temperature and Humidity 0x0e
	High-Precision Tilt 0x0f
	Ultrasonic Level 0x10
	4-20mA Loop 0x11
	Air Temp and Humidity – External Probe 0x12
	Thermocouple 0x13
	Voltmeter 0x14
	Custom (for customized sensors) 0x15
	GPS 0x16
	Honeywell 5800 Bridge 0x17
	Magnetometer 0x18
	Internal Temp Sensor 0x19
	Compass Sensor 0x1A
	Weather Station Bridge 0x1B
	Vibration Sensor High Bandwidth 0x1C-0x20

Bytes	Description
1	Hardware version.
2-3	Firmware version.
4-5	Reset code. Used for factory diagnostics.

Firmware Version

The 16-bit firmware version is constructed from reset payload Bytes 2-3, where Byte 2 is the most significant byte. Beginning with version 2.0, the format is as shown in the following table.

The original format is compatible by redefining the reserved most significant bit (Bit 15).

Byte	Description
15	Format (bit == 0)
14:8	Major number (7 bits)
7:0	Minor number (8 bits)
15	Format (bit == 1)
14:10	Major number (5 bits)
9:5	Minor number (5 bits)
4:0	Build number (5 bits)

16-Bit Firmware Version Examples

- 0x0103 is decoded as Firmware Version 1.3
- 0x8823 is decoded as Firmware Version 2.1.3

Supervisory Message (0x01)

Wireless sensors periodically (19 hours by default) send a supervisory message so the backend system can verify the device is still alive and report error conditions. The supervisory message payload include current sensor status.

You can also trigger a supervisory message. To do this:

- Place a magnet near the triangular notch on the side of the sensor.

The following table shows the supervisory message payload:

Bytes	Description														
0	Supervisory error codes as follows: <table border="1"> <thead> <tr> <th>Bits</th> <th>Description</th> </tr> </thead> <tbody> <tr> <td>7:5</td> <td>Not used.</td> </tr> <tr> <td>4</td> <td>Tamper detected since last reset.</td> </tr> <tr> <td>3</td> <td>Current tamper state.</td> </tr> <tr> <td>2</td> <td>Error with last downlink.</td> </tr> <tr> <td>1</td> <td>Battery low (under 2.8v).</td> </tr> <tr> <td>0</td> <td>Radio communication error, communication with the integrated radio failed and the device was reset.</td> </tr> </tbody> </table>	Bits	Description	7:5	Not used.	4	Tamper detected since last reset.	3	Current tamper state.	2	Error with last downlink.	1	Battery low (under 2.8v).	0	Radio communication error, communication with the integrated radio failed and the device was reset.
Bits	Description														
7:5	Not used.														
4	Tamper detected since last reset.														
3	Current tamper state.														
2	Error with last downlink.														
1	Battery low (under 2.8v).														
0	Radio communication error, communication with the integrated radio failed and the device was reset.														
1	Current sensor state, 1-byte. This is device specific, refer Sensor Specific Messages chapter for details. For other devices, use the periodic reporting feature.														
2	Battery level is a two-digit battery voltage. For example, if the battery voltage is 2.9V, byte 2 would be 0x29.														
3-6	Extended sensor state, 4-bytes. Allows sensors with higher precision or multiple values to report during a supervisory event. For other devices, use the periodic reporting feature. Note: For applications requiring periodic readings, using the periodic reporting feature is recommended. Refer to <i>Periodic Reports</i> . in Sensor Specific Downlink Messages.														
7-8	Event accumulation count is the number of sensor events since the last supervisory message. To improve battery life, can be used with the Disable all sensor events setting so only an event total is reported during a supervisory message, individual events are not reported as they occur. This feature is available in firmware v2.0 and beyond.														

Tamper Message (0x02)

A sensor sends a message when the tamper switch has been opened or closed through either an enclosure tamper or a wall mount tamper. The tamper message contains a 1-byte payload as shown in the following table.

Payload	Description
0x00	Tamper switch opened.
0x01	Tamper switch closed.

Downlink ACK (0xFF)

The cloud app uses this downlink ACK message to verify that the sensor received the downlink message and it was considered valid.

The sensor replies to the downlink data with a 0xFF message (downlink ACK) with the payload shown in the following table.

Command	Payload
0x00	Not used
0x01	Message was invalid or undefined
0x02	Message was valid

Link Quality Message (0xFB)

The link quality message provides a signal strength and a signal to noise measurement at the device itself. The link quality message payload is shown in the following table.

Bytes	Description
0	Current Sub-Band, sub-band currently joined and used for communication to the gateway and network server. Value ranges from 1-8 for US915. For other regions, value depends on available channels.
1	RSSI of last DOWNLINK received, signed integer format values in bytes 1 and 2 in two's complement format.
2	SNR of last DOWNLINK received, signed integer format values in bytes 1 and 2 in two's complement format.

Downlink Messages

Downlink messages are from the cloud to the sensor and are used to configure the sensor. The sensor initiates receiving downlink messages upon transmitting, since the sensor is typically sleeping with the radio turned off.

All downlink messages must contain 8 bytes, padded with zeroes.

A downlink will be received after any uplink within the receive window.

The following command messages can be sent back to the sensor as downlink.

Command	Payload	Description
0x00	Not used	Not used
0x01	4 bytes	General configuration
--	0-7 bytes	Sensor configuration, refer to the <i>Sensor Specific Messages</i> chapter
0xED	1 byte	Device Info Request (<i>Firmware version 3.0 or newer</i>)
0xEE	1 byte	Link quality configuration (<i>Firmware version 3.0 or newer</i>)
0xEF	4 bytes	ADR Advanced configuration (<i>Firmware version 3.0 or newer</i>)
0xFC	3 bytes	Advanced configuration

General Configuration

Use the general configuration command to configure parameters that apply to all sensor types.

Byte	Description
0x00	Disable sensor events
0x01	Radio config
0x02	Supervisory period. Default 19 hours.
0x03	Sampling rate

Disable Sensor Events

The following table shows the disable sensor event bit definitions.

Bit	Description
7:1	Not used
0	Disable all sensor events

Radio Config

The following table shows the radio config byte definition.

Note: Available in firmware version 1.4 or newer.

Bits	Description
7	Not used (reserved)
6	Enable duty cycle requirement. <i>EU868 only</i> . To enforce the EU868 band duty cycle requirements, enable before production deployment. Cannot be disabled. Available in firmware 2.2.1 or later.
5:2	Uplink retries. . The range for uplink retries is 1-8 for confirmed messages (ACK required) and does not apply to unconfirmed messages. Default 0 (leave unchanged). Available in firmware v1.4 and above.
1	Use unconfirmed messages. If set to use the unconfirmed messages bit, the sensor does not look for an ACK from the network server. Default is 1 (unconfirmed messages, no ACK required). EU sensors can't use confirmed messages, setting this bit to 0 on an EU device causes an invalid downlink error (0xFF01). Available in firmware v1.4 and above.
0	Disable Adaptive Data Rate (ADR). To enable ADR, set to 0. To disable ADR, set to 1. Default is 0 (enabled). Available in firmware v1.3 and above.

Important: The duty cycle bit is always set for production deployments in the EU868 band. It cannot be changed.

Supervisory Period

The general configuration command's supervisory period controls the time between supervisory messages as defined in the following table.

Bit 7	Bits 6:0
0	Period defined in hours (1-127 hours). Available in firmware v1.3 and above.
1	Period defined in minutes (1-127 minutes) Available in firmware v1.3 and above.

For example, to receive a report every 4 hours, set Byte 1 to 0x04. To receive a periodic report every 15 minutes, set Byte 1 to 0x8f.

Sampling Rate

Sampling rate controls the frequency at which devices wake from low power sleep mode to check the sensor state. Some sensors require very little power to check the state and need to react quickly. Other sensors can be sampled at a lower rate, such 30-second or 30-minute intervals. Increasing the time between samples increases battery life.

Refer to the Battery Estimator for battery life estimates relative to sampling rate:
<https://radiobridge.com/documents/Sensor%20Battery%20Estimator.xlsx>

A value of 0 in this field leaves the sampling rate at the current value. Use the following table to determine the sampling rate if the value is not zero.

Note: Sampling period only applies to sensors that take measurements like temperature and tilt, it does not apply to sensors with binary inputs such as door/window sensors or push buttons.

This feature is available in firmware v2.0 and above.

Bit 7:6	Bits 5:0
00	Sampling period defined in increments of 250ms (0.25-15 seconds).
01	Sampling period defined in increments of seconds (1-63 seconds).
10	Sampling period defined in increments of minutes (1-63 minutes).
11	Sampling period defined in increments of hours (1-63 hours).

Device Info Request

The Device Info Request command is a downlink to inform the gateway to report its downlink configuration information.

Bit	Description
0x00	<p>Downlink configuration type to request.</p> <p>0-254: Request device info for specific downlink type to report.</p> <p>255: Request device info for all downlink configurations.</p>

Link Quality Configuration (0xEE)

The Link Quality configuration command configures the number of failed confirmed message attempts before re-entering the LoRaWAN join state.

Byte	Description
0x00	<p>Number of failed confirmed message transmits before the device re-enters a LoRaWAN join state. The default value is 12.</p> <p>When the device transmits a confirmed message and exhausts uplink retries without receiving an acknowledgment, the device increments an internal failed counter by 1. This counter not increment if the message being transmitted is not a confirmed message.</p> <p>If this counter does not exceed the threshold specified in this byte, the device attempts a retransmit.</p> <p>The default value is 12.</p>

ADR Advanced Configuration

The ADR configuration message overrides the LoRaWAN ADR_ACK_LIMIT and ADR_ACK_DELAY parameters.

Byte	Description
0x00	ADR_ACK_LIMIT value when running in Unconfirmed Mode. The default value is 64.
0x01	ADR_ACK_DELAY value when running in Unconfirmed Mode. The default value is 32.
0x02	ADR_ACK_LIMIT value when running in Confirmed Mode. The default value is 2.
0x03	ADR_ACK_DELAY value when running in “Confirmed Mode”. The default value is 1.

For additional details with usage to ADR_ACK_LIMIT and ADR_ACK_DELAY, refer to *LoRaWAN Link Layer Specification v1.0.4 - Section 4.3.1.1: Adaptive data-rate control in frame header*.

Factory Reset (0xEC)

Restores all setting to factory defaults. Does not preserve any custom configuration.

- In US915, the device returned the device information message.
- In EU868, the device returns that downlink confirmation.

Advanced Configuration (0xFC)

Use this command for advanced configuration parameters that apply to all sensor types. The advanced configuration command is defined in the following table.

Byte	Description
0x01	Port number
0x02	Link quality check period

Port Number

Byte 0x01 of the advanced configuration command changes the uplink port per the LoRaWAN protocol. The default port is 2, and a value of 0 in this field means to leave it at the default.

This feature is available in firmware v1.4 and above.

Link Quality Check Period

Setting this register causes the device to ping the network server periodically with a requested ack. Typically used with unconfirmed messages, this feature creates a periodic confirmed message and looks for the ack to ensure the device is still connected.

The following table shows this byte’s encoded bit definitions.

Available in firmware v2.0 and above.

Bit 7	Bits 6:0
0	Period defined in hours (1-127 hours).
1	Period defined in minutes (1-127 minutes)

Chapter 6 – Sensor-Specific Messages

Uplink Messages

The uplink message (sensor to web application) specific to the sensor is defined in following table. The common uplink messages are not included in this section (see common messages document).

Byte	Description
0x00	Tilt event
0x01	Tilt angle from vertical axis

The tilt events are defined in the following table.

Event	Description
0x00	Sensor transitioned to vertical
0x01	Sensor transitioned to horizontal
0x02	Report on change toward vertical
0x03	Report on change toward horizontal

The first two event messages are sent when the tilt angle exceeds the horizontal threshold or falls below the vertical threshold. Note that the angle is relative to a vertical orientation, so small angles are closer to vertical and large angles are closer to horizontal.

The report-on-change messages are sent when the tilt angle increases (toward horizontal) or decreases (toward vertical) a specified amount from the last report. For example, consider a report-on-change value that is set to 5 degrees and the current angle from the vertical axis is 15 degrees. If the angle increases to 20 degrees an 0x03 event is sent. If the angle decreases back to 15 degrees, an 0x02 event is sent.

Downlink Messages

The downlink message (web application to sensor) specific to the vibration sensors are defined in this section. The common downlink messages are not included in this section (see common messages document).

Byte	Description
0	Control byte (see the table Control Byte Bit Definitions)
1	Angle for transition to horizontal state in degrees. Default 55 degrees.
2	Angle for transition to vertical state in degrees. Default 35 degrees.
3	Vertical hold time
4	Horizontal hold time
5	Report-on-change toward vertical (0-90 degrees)
6	Report-on-change toward horizontal (0-90 degrees)

Thresholds

The angle in bytes 1 and 2 define the angle in degrees off of the vertical axis that the sensor needs to be tilted to generate an alert. For example, if the sensor is used to detect garage open/close events, the vertical threshold might be set at 35 degrees and the horizontal threshold may be set at 55 degrees. It is not recommended to set both to the same values (both at 45 degrees for instance) since this may generate multiple alerts when it is oriented near the threshold. The range for each threshold is 0-90 degrees where 0 is completely vertical and 90 is completely horizontal.

Hold Time

The hold times are 8-bit values that represent the amount of time the tilt sensor must be held in a particular orientation before a message is sent. The hold time values range from 1-255 and are represented in 250ms increments. This gives the hold times a range of 250 milliseconds – 1 minute. If the hold time is 0, the feature is disabled and an alert will be sent any time the orientation changes.

Report-On-Change

The report-on-change feature will create an alert when the angle of the tilt increases or decreases by a specified amount. This allows for detecting a tilt when the initial orientation is not completely vertical. For example, one could place the sensor on a telephone pole and set a report-on-change event for 10 degrees. This configuration will send an alert if the pole leans another 10 degrees from its current position.

The minimum value for the report-on-change angle is 5 degrees. A setting less than this will disable the feature.

Control Byte

The table below describes the control byte bit definitions.

Bits	Description
7:4	Not used
3	Disable report-on-change toward vertical. Default disabled
2	Disable report-on-change toward horizontal. Default disabled
1	Disable transitions to vertical orientation only. Default enabled
0	Disable transitions to horizontal orientation only. Default enabled

Chapter 7 – Regulatory Information

47 CFR Part 15 Regulation Class B Devices

This equipment has been tested and found to comply with the limits for a Class B digital device, pursuant to part 15 of the FCC Rules. These limits are designed to provide reasonable protection against harmful interference in a residential installation. This equipment generates, uses, and can radiate radio frequency energy and, if not installed and used in accordance with the instructions, may cause harmful interference to radio communications. However, there is no guarantee that interference will not occur in a particular installation.

If this equipment does cause harmful interference to radio or television reception, which can be determined by turning the equipment off and on, the user is encouraged to try to correct the interference by one or more of the following measures:

- Reorient or relocate the receiving antenna.
- Increase the separation between the equipment and receiver.
- Connect the equipment into an outlet on a circuit different from that to which the receiver is connected.
- Consult the dealer or an experienced radio/TV technician for help.

Warning: Changes or modifications to this unit not expressly approved by the party responsible for compliance could void the user's authority to operate the equipment.

Federal Communications Commission (FCC)

Per FCC 15.19(a)(3) and (a)(4) This device complies with part 15 of the FCC Rules. Operation is subject to the following two conditions: (1) This device may not cause harmful interference, and (2) this device must accept any interference received, including interference that may cause undesired operation.

Per FCC 15.21, Changes or modifications not expressly approved by MultiTech could void authority to operate the devices.

LoRaWAN RBS301, RBS304, and RBS305 sensors FCC ID: 2APNUCMABZ

LoRaWAN RBS306 sensors: This device contains FCC IAU792U13A16858

This device contains equipment certified under IC: 125A-0055

LoRaWAN RBS301 Wireless Sensor:

- FCC ID: AU792U22A05869
- IC: 125A-0066

Industry Canada Class B Notice

This Class B digital apparatus meets all requirements of the Canadian Interference-Causing Equipment Regulations.

Cet appareil numérique de la classe B respecte toutes les exigences du Règlement Canadien sur le matériel brouilleur.

This device complies with Industry Canada license-exempt RSS standard(s). The operation is permitted for the following two conditions:

1. the device may not cause interference, and
2. this device must accept any interference, including interference that may cause undesired operation of the device.

Le présent appareil est conforme aux CNR d'Industrie Canada applicables aux appareils radio exempts de licence. L'exploitation est autorisée aux deux conditions suivantes:

1. l'appareil ne doit pas produire de brouillage, et
2. l'appareil doit accepter tout brouillage radioélectrique subi, même si le brouillage est susceptible d'en compromettre le fonctionnement.

EMC, Safety, and R&TTE Directive (RED) Compliance



The CE mark is affixed to this product to confirm compliance with the following European Community Directives:

Council Directive 2011/65/EU on the restriction of the use of certain hazardous substances in electrical and electronic equipment;

and

Council Directive 2014/53/EU on radio equipment and telecommunications terminal equipment and the mutual recognition of their conformity.

and

Council Directive 2014/35/EU on the harmonization of the laws of Member States relating to Electrical Equipment designed for use within certain voltage limits.

MultiTech declares that this device is in compliance with the essential requirements and other relevant provisions of Directive 2014/53/EU. The declaration of conformity may be downloaded at <https://www.multitech.com/red>

Standards

Directive	Description	Applicable Standards
2014/35/EU Art. 3,1 2011/65/EU	LVD	EN 62368-1:2014 + A11:2017
2014/53/EU	MPE /RF Exposure	EN 62311:2008
	ROHS	EN IEC 63000:2018

Directive	Description	Applicable Standards	
2014/53/EU	RED	Art 3.1b EN 301 489-1 V2.1.1 (General) EN 301 489-3 V2.1.2 (SRD devices) EN61326 (Lab Equip)	Art. 3.2 EN 300 220-2 V3.1.1 and v3.2.1(SRD devices)

Harmonized Commodity Description (HS Code)

The Harmonized Commodity Description and Coding System generally referred to as “Harmonized System” or simply “HS” is a multipurpose international product nomenclature developed by the World Customs Organization (WCO).

HS Code: 8531.90.9001

Export Control Classification Number (ECCN)

ECCNs are five character alpha-numeric designations used on the Commerce Control List (CCL) to identify dual-use items for export control purposes. An ECCN categorizes items based on the nature of the product, i.e. type of commodity, software, or technology and its respective technical parameters.

ECCN: 5a992.c

Chapter 8 – Environmental

REACH-SVHC Statement

Registration of Substances

Multi-Tech Systems, Inc. confirms that none of its products or packaging contain any of the Substances of Very High Concern (SVHC) on the REACH Candidate List, in a concentration above the 0.1% by weight allowable limit.

For the current REACH-SVHC statement, refer to additional regulatory documents at:

<https://www.multitech.com/support/support>

Waste Electrical and Electronic Equipment Statement

Note: This statement may be used in documentation for your final product applications.

WEEE Directive

The WEEE Directive places an obligation on EU-based manufacturers, distributors, retailers, and importers to take-back electronics products at the end of their useful life. A sister directive, ROHS (Restriction of Hazardous Substances) complements the WEEE Directive by banning the presence of specific hazardous substances in the products at the design phase. The WEEE Directive covers all MultiTech products imported into the EU as of August 13, 2005. EU-based manufacturers, distributors, retailers and importers are obliged to finance the costs of recovery from municipal collection points, reuse, and recycling of specified percentages per the WEEE requirements.

Instructions for Disposal of WEEE by Users in the European Union

The symbol shown below is on the product or on its packaging, which indicates that this product must not be disposed of with other waste. Instead, it is the user's responsibility to dispose of their waste equipment by handing it over to a designated collection point for the recycling of waste electrical and electronic equipment. The separate collection and recycling of your waste equipment at the time of disposal will help to conserve natural resources and ensure that it is recycled in a manner that protects human health and the environment. For more information about where you can drop off your waste equipment for recycling, contact your local city office, your household waste disposal service or where you purchased the product.

July, 2005



Restriction of the Use of Hazardous Substances (RoHS)

Multi-Tech Systems, Inc.

Certificate of Compliance

2015/863

Multi-Tech Systems, Inc. confirms that its embedded products comply with the chemical concentration limitations set forth in the directive 2015/863 of the European Parliament (Restriction of the use of certain Hazardous Substances in electrical and electronic equipment - RoHS 3).

These MultiTech products do not contain the following banned chemicals¹:

- Lead, [Pb] < 1000 PPM
- Mercury, [Hg] < 100 PPM
- Cadmium, [Cd] < 100 PPM
- Hexavalent Chromium, [Cr+6] < 1000 PPM
- Polybrominated Biphenyl, [PBB] < 1000 PPM
- Polybrominated Diphenyl Ethers, [PBDE] < 1000 PPM
- Bis(2-Ethylhexyl) phthalate (DEHP): < 1000 ppm
- Benzyl butyl phthalate (BBP): < 1000 ppm
- Dibutyl phthalate (DBP): < 1000 ppm
- Diisobutyl phthalate (DIBP): < 1000 ppm

Environmental considerations:

- Moisture Sensitivity Level (MSL) =1
- Maximum Soldering temperature = 260C (in SMT reflow oven)

¹Lead usage in some components is exempted by the following RoHS annex, therefore higher lead concentration would be found in some modules (>1000 PPM);

- Resistors containing lead in a glass or ceramic matrix compound.